

DİLAY ORTA SEHPA DİLAY MIDDLE TABLE

MONTAJ VE KULLANIM KLAVUZU ASSEMBLY MANUEL

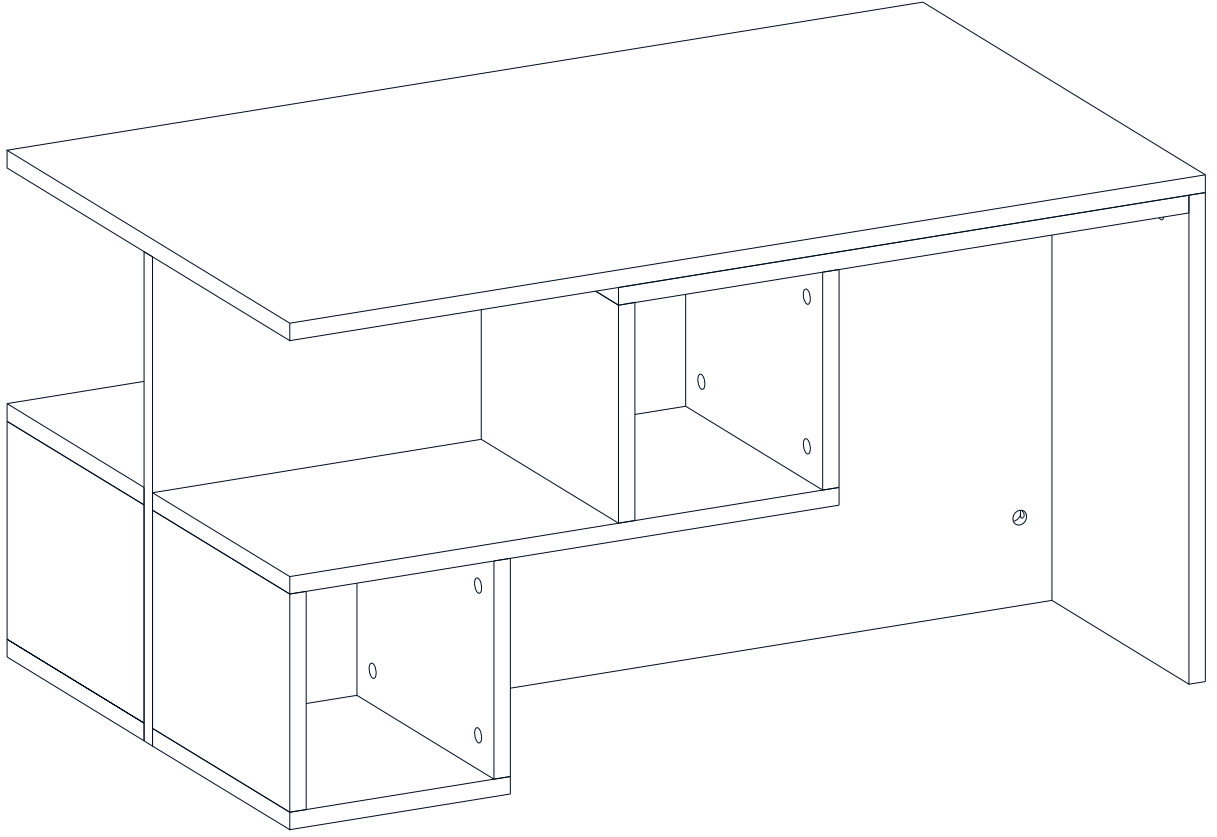

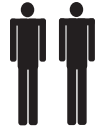



Bu modül iki kişi tarafından kurulmalıdır.
This unit should be assembled by two persons.



Bu modülün kurulumu için gerekli olan araçlar.
The necessary tools (not included)

ZMC ENG'S DESIGN
KATILARI İLE HAZIRLANMIŞTIR...

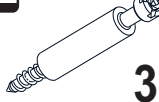
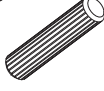
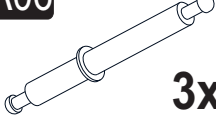
AKSESUAR LİSTESİ / ACCESSORY LIST

A09 3x30 YHB Vida  4x	A01 Minifix Gövde  43x	A02 Minifix Mil  37x	A03 Kavela  43x	A06 Minifix Mil (Uzun)  3x
A16 Vida Tapa 1. RENK 7x 2. RENK 40x 				

PARÇA KODLAMA / GENERAL VIEW

